

# BMV

Sharp Innovators

POTATRICE  
A VERDE E A SECCO  
PER AGRUMETI, ULIVETI, FRUTTETI

serie

# FL480S-FL480U



[bmv-italy.com](http://bmv-italy.com)



Sharp Innovators

# POTATRICE serie FL480S-FL480U

## FL480U

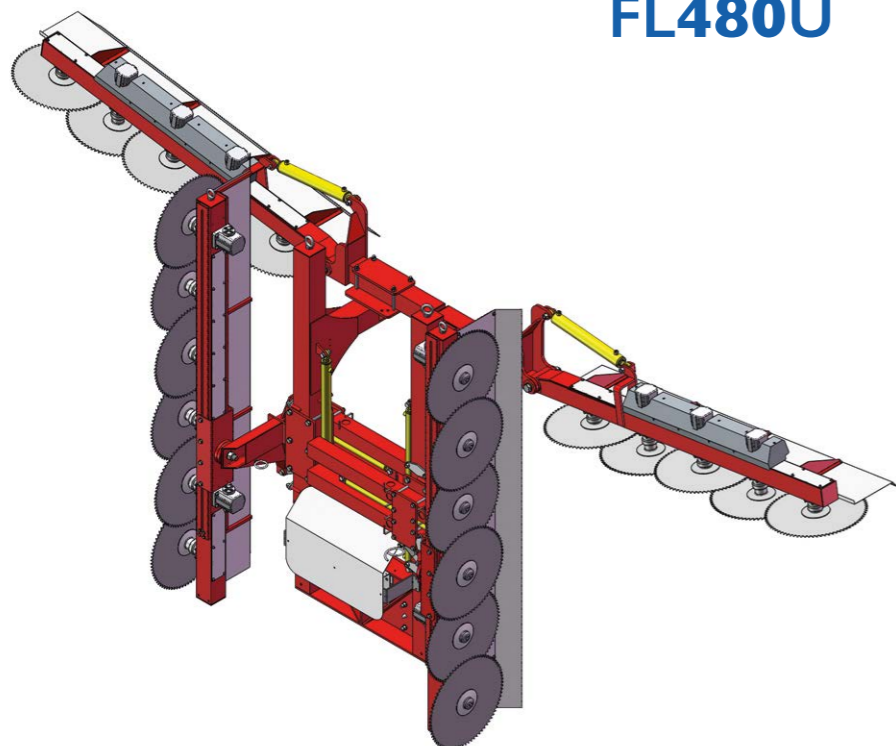

## FL480S

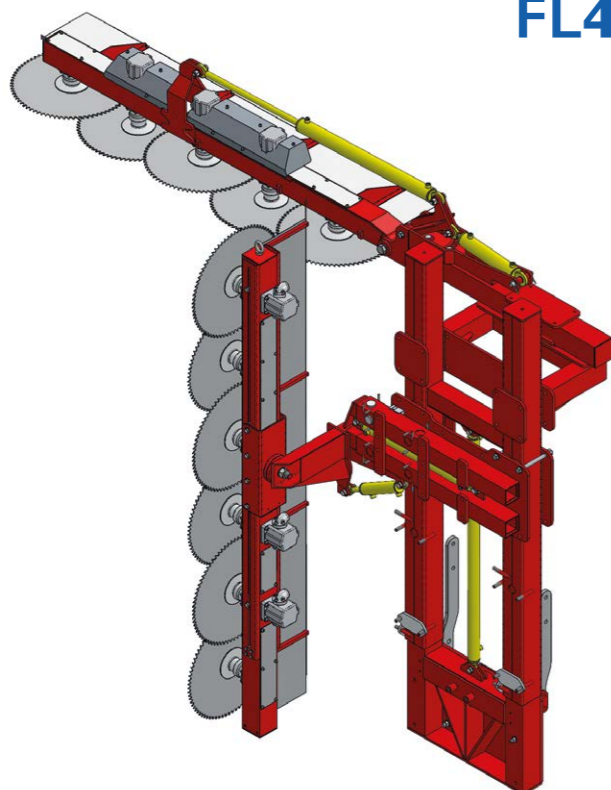

STRUMENTI  
DI TAGLIO



DISCO WIDIA  
PER TAGLI A SECCO



COLTELLO  
SCIABOLA

CONTROLLI



JOYSTICK ABBINATO  
A DISTRIBUTORE ELETTRICO

SERBATOIO



SERBATOIO  
120 LT.



SERBATOIO  
80 LT.  
(solo FL480S)

ATTACCHI



ATTACCO  
FISSO



ATTACCO  
3 PUNTI



### KIT VENTOLA SOFFIO CON TUBI E BOCCHETTONI ARIA REGOLABILI SU GRUPPO TAGLIO PER FL480S

Il kit sopra, grazie ad innocui getti d'aria, piega verso l'interno, preservandoli, i rami flessibili degli ulivi intensivi, che riprendono la loro posizione dopo il passaggio della macchina.

In questo modo, la parete si ricopre della vegetazione salvata e i rami riprendono la loro posizione naturale.

















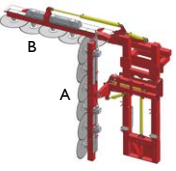
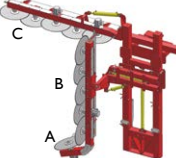

Sharp Innovators

# POTATRICE serie FL480S-FL480U

## INFORMAZIONI TECNICHE / Technical Information / Información técnica

MODELLO Model Modelo				A	B	C						
	A	B	C									
	N°											
<b>FL480S</b> 	6	5	-	240	200	-	38	50	850	90	60	8-10
<b>FL480SC</b> 	1	5	5	50	200	200	38	50	850	90	60	8-10

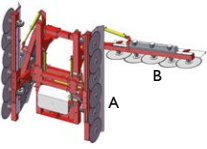
MODELLO Model Modelo			A	B						
	A	B								
	N°									
<b>FL480U</b> 	6	5	240	200	38	50	1050	90	60+60	8-10

[bmv-italy.com](http://bmv-italy.com)

Strada Forcellini, 5 - 12051 - Alba (CN) - Italy  
T. +39 0173 35450 - F. +39 0173 35214 - [bmv@bmv-italy.com](mailto:bmv@bmv-italy.com)

